

**Dantherm**<sup>®</sup>  
CLIMATE SOLUTIONS



PORTABLE CONDENSATION DEHUMIDIFIERS

**CDT 30-30S-40-40S-60-90**

IDEAL FOR RENTAL AND CONSTRUCTION COMPANIES

DANTHERMGROUP

## About the Dantherm Group

Originally founded in 1954, the Dantherm Group is a European leader in portable and installed climate control solutions for a wide range of industries and uses. Based on the work of more than 500 passionate climate control experts and more than three million installations, our competence centres around Europe design and build exceptional heating, cooling, dehumidification and ventilation units that form the backbone of these climate solutions. In everything they do, they remain focused on creating healthy and comfortable climate surroundings in a sustainable, energy-efficient and cost-effective way.



Five competence centres in Denmark, Germany, Italy, Spain and UK.

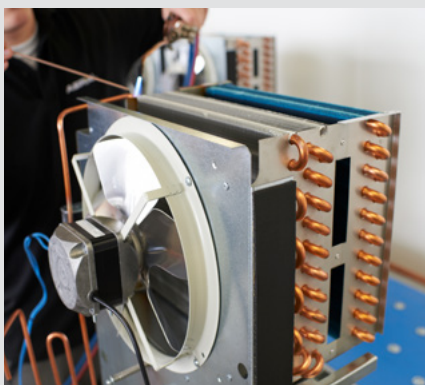



**Competence centre**  
for portable drying solutions: Norderstedt, Germany.



Our drying competence centre near Hamburg, Germany, has more than 30 years of experience in developing innovative and user-friendly dehumidifiers and drying solutions that are renowned for their sturdiness, flexibility and hassle-free operation.

# CDT SERIES – MOBILE DEHUMIDIFICATION

## QUICK AND EASY HUMIDITY CONTROL



**Dantherm mobile CDT dehumidifiers offer quick and easy control for water damage restoration companies and the construction industry. The units are renowned for their user-friendliness, superior digital control and light yet robust design.**

Damage control in case of flooding, water pipes or as a side-effect from fire fighting requires fast and efficient dehumidification. This is why water damage companies all over the world prefer the Dantherm CDT range of mobile dehumidifiers for the job. They are fast and energy-efficient. They offer precise digital settings, service information, easy fault-finding and exact specification of hour and energy consumption as well as readings of temperature and relative humidity. On top of this they are designed for optimal transport and handling.

### Speed up the drying process

Dantherm CDT units are also popular within the building industry, because of their user-friendly design and mobility. They offer an effective and carefully controlled means of drying out brick or concrete walls to save both time and money without forcing the process unduly. Furthermore, the CDT units are designed to meet modern demands for low energy consumption.

### High-performance and digital control

The CDT range offers capacities from 29 to 86 l/24h and a maximum working temperature of 35°C, as well as superior control of settings and operations. The digital touchscreen display puts you in quick and easy control of humidity and service status. Furthermore, hours and energy consumption can be read off the display.

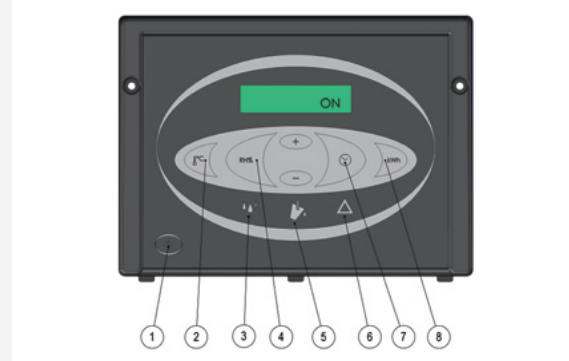

### Electronic control

The digital display with integrated humidity control, energy counter, service status and easy fault finding allows optimal dehumidification:

Benefits:

- Digital touchscreen control panel with display
- Accurate hour and kWh counter (reading)
- RH and °C monitoring (reading)
- RH setting
- Easy fault-finding
- Service monitoring function

Digital touchscreen control panel:

1. On-off switch
2. Reading of room temperature
3. Indicator for normal operation (green lamp)
4. Reading of RH value/setting of RH value
5. Indicator for full water container (yellow lamp)
6. Failure indicator (red lamp)
7. Hour counter/setting of service intervals
8. kWh counter

### New refrigerant

Fully complying with EU's F-gas regulation, which aims to phase out usage of HFCs, all units use the eco-friendly and durable R454C refrigerant. Ideal for a broad temperature range, it is very suitable for rental and fleet equipment subjected to frequent transportation to and from different sites and offers the flexibility needed by fleet operators. R454C is mildly flammable – check local legislation for any maximum coolant storage limits.



### Easy and safe transport

The CDT units have been carefully designed for easy handling and transport. Adjustable and fixed handles ensure safe and convenient handling and operation. Big rubber wheels make the CDT's easy to move both up and down stairs and across seemingly impassable areas. The wheels are in line with the sides of the unit to make it as narrow as possible and to protect doors and panels from unnecessary knocks. During transport and storing, the CDT units can be stacked requiring as little space as possible.

### Special versions with air ducts

CDT 30S and CDT 40S are fitted with a 1kW heating element, a high pressure fan and two duct spigots allowing connection of flexible air ducts. This is particularly suitable for drying out wet wooden floors.

### Optional remote monitoring

Imagine not having to go on-site and check manually if a dehumidification process has been completed. With the optional integration to Dantherm Group's remote monitoring solution SIMPLIFY CLIMATE SOLUTIONS, you can check the dehumidifying status in real-time from computers, smart phones and tablets no matter where you are. In addition, the solution enables users to remotely monitor and control parameters such as power on/off, alarms, temperature and power consumption.

### CDT with condensate pump

The CDT dehumidifiers can be supplied with a condensate pump cassette, which is fitted instead of the water container. It pumps the condensate water into a drain. Using this condensate pump will enable your dehumidifier to run maintenance-free, you will no longer have to empty a heavy reservoir filled with water. The lifting height is max. 3m. The condensate pump cassette is available as accessory.



CDT 30S and CDT 40S are fitted with a 1kW heating element, a high pressure fan and two duct spigots, allowing connection of two flexible air ducts Ø100, each up to 5m long.

Big rubber wheels ensure safe and easy manoeuvring.

### Applications

- Water damage restoration
- Building drying
- Waterworks
- Dry storing

### Technical data

	Dehumidification capacity at		Operating range humidity %RH	Operating range temperature °C	Height with handle down mm	Height with handle up mm	Width mm	Depth mm	Weight kg	Water tank l
	20°C/60% RH	30°C/80% RH								
CDT 30	15.1	31.9	40-100	3-35	736	1016	426	506	31	7
CDT 30S	14.4	34.4	40-100	3-35	736	1016	426	506	33	7
CDT 40	18.4	43.5	40-100	3-35	823	1190	542	539	40	14
CDT 40S	18.6	43.5	40-100	3-35	823	1190	542	539	43	14
CDT 60	28.4	65.0	40-100	3-35	903	1270	542	539	46	14
CDT 90	37.0	86.5	40-100	3-35	977	977	650	593	62	-

# PORTABLE CONDENSATION DEHUMIDIFIERS

## CDT 30-30S



The CDT 30/CDT 30S is a robust, cost-effective and energy-efficient, reliable mobile dehumidifier. It works in accordance with the condensation principle. A fan draws the humid air into the dehumidifier and through an evaporator coil. When passing through the evaporator the air is cooled down to below its dew point temperature, and its content of water vapour is condensed into water, which is collected in the water container.

### CDT 30S:

- Fitted with a 1kW heating element
- High pressure fan
- Two duct spigots, allowing connection of two flexible air ducts Ø100, each up to 5m long



- Electronic control display
- Water container with handles
- Automatic stop when water container is full or removed
- High capacity
- Low energy consumption
- F-gas regulation 2020 compliant refrigerant
- Strong and robust cabinet of powder-coated hot galvanized steel with active defrosting
- Epoxy-coated evaporator and condenser
- Adjustable handle
- Plastic bumpers
- Low weight
- Stackable
- Big wheels
- Can be integrated with Remote Monitoring Solution from Dantherm Group

### Optional accessories



**Hygrostat with 0.4m cable, jack plug and fitting**  
396242



**Hygrostat with 3m cable and jack plug**  
396241



**1/2" draining tap and screwed hose connector**  
396243



**Wall bracket CDT 30/CDT 30S:**  
396247



**Spare filter CDT 30/CDT 30S:**  
035862



**Cassette with built-in condensate pump CDT 30/CDT 30S:**  
075616

Specifications	Units	CDT 30	CDT 30S
Capacity (30°C/80% RH)	l/24h	31.9	34.4
Capacity (20°C/60% RH)	l/24h	15.1	14.4
Air flow	m³/h	250	350*
Operating temperature range	°C	3-35	3-35
Operating humidity range	% RH	40-100	40-100
Max. power consumption	W	800	1800 with heating element/800 without
Power supply	V/Hz	230/50	230/50
Sound level @1m	dB(A)	56	56**
Refrigerant		R454c	R454c
Water tank	l	7	7
Protection class		IP X4	IP X4
Height with handle down	mm	736	736
Width	mm	426	426
Depth	mm	506	506
Weight	kg	31	33

\*Measured without air ducts mounted.\*\*Measured with air ducts mounted.

# PORTABLE CONDENSATION DEHUMIDIFIERS

## CDT 30-30S

### Dimensions

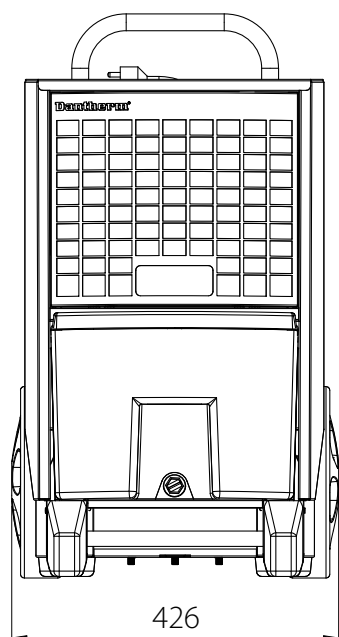

### CDT 30

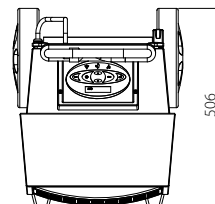
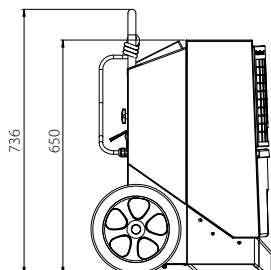

### CDT 30S

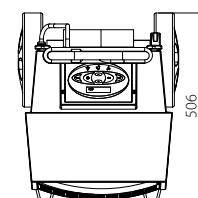
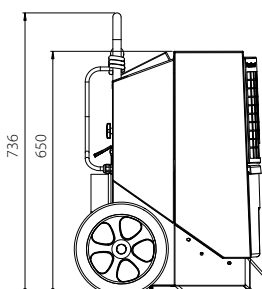

All measurements are in mm

### Performance data

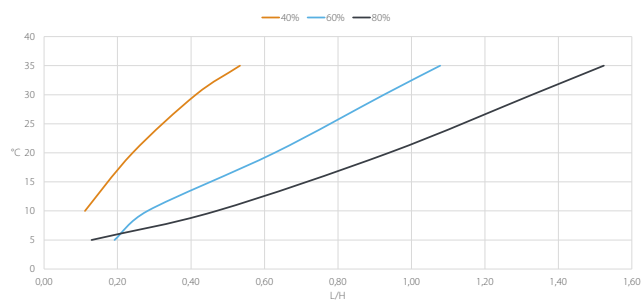

### CDT 30

#### Specific energy consumption (SEC)

0.53 kWh/l at 30°C & 80% RH

0.85 kWh/l at 20°C & 60% RH

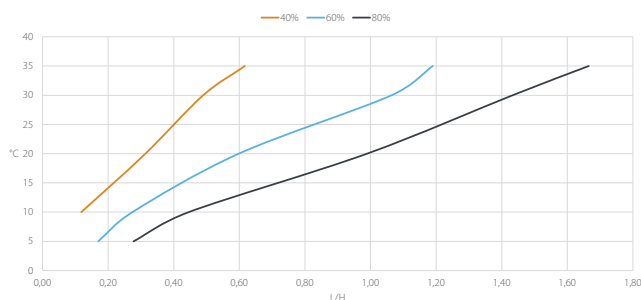

### CDT 30S

#### Specific energy consumption (SEC)

0.51 kWh/l at 30°C & 80% RH

0.86 kWh/l at 20°C & 60% RH

The active, demand-controlled defrosting is activated through a temperature sensor on the evaporator. Defrosting is done by means of hot refrigerant being fed through the evaporator.

# PORTABLE CONDENSATION DEHUMIDIFIERS

## CDT 40-40S



**CDT 40-40S**

The CDT 40 is a robust, cost-effective and energy-efficient, reliable mobile dehumidifier. It works in accordance with the condensation principle. A fan draws the humid air into the dehumidifier and through an evaporator coil. When passing through the evaporator the air is cooled down to below its dew point temperature, and its content of water vapour is condensed into water, which is collected in the water container.

### CDT 40S:

- Fitted with a 1kW heating element
- High pressure fan
- Two duct spigots, allowing connection of two flexible air ducts Ø100, each up to 5m long



- Electronic control display
- Water container with handles
- Automatic stop when water container is full or removed
- High capacity
- Low energy consumption
- F-gas regulation 2020 compliant refrigerant
- Strong and robust cabinet of powder-coated hot galvanized steel
- Epoxy-coated evaporator with active defrosting and condenser
- Adjustable handle
- Plastic bumpers
- Low weight
- Stackable
- Big wheels
- Can be integrated with Remote Monitoring Solution from Dantherm Group

### Optional accessories



**Hygrostat with 0.4m cable, jack plug and fitting**  
396242



**Hygrostat with 3m cable and jack plug**  
396241



**1/2" draining tap and screwed hose connector**  
396243



**Wall bracket CDT 40/40S:**  
396248



**Spare filter CDT 40/CDT 40S**  
035973



**Cassette with built-in condensate pump CDT 40/CDT 40S**  
075617

Specifications	Units	CDT 40	CDT 40S
Capacity (30°C/80% RH)	l/24h	43.5	43.5
Capacity (20°C/60% RH)	l/24h	18.4	18.6
Air flow	m <sup>3</sup> /h	350	560*
Operating temperature range	°C	3-35	3-35
Operating humidity range	% RH	40-100	40-100
Max. power consumption	W	900	1900 with heating element/900 without
Power supply	V/Hz	230/50	230/50
Sound level @1m	dB(A)	57	58**
Refrigerant		R454c	R454c
Water tank	l	14	14
Protection class		IP X4	IP X4
Height with handle down	mm	823	823
Width	mm	542	542
Depth	mm	539	539
Weight	kg	40	43

\*Measured without air ducts mounted.\*\*Measured with air ducts mounted.



# PORTABLE CONDENSATION DEHUMIDIFIERS

## CDT 40-40S

### Dimensions

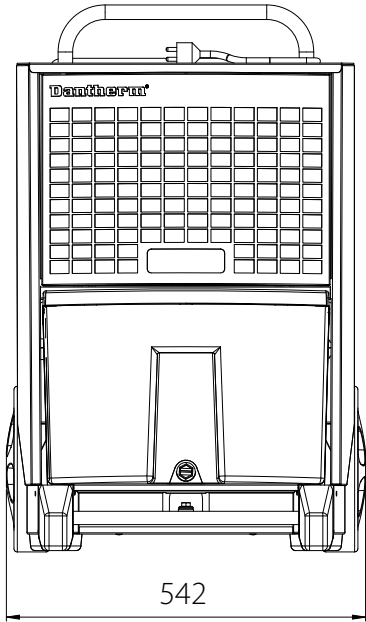

### CDT 30

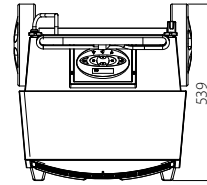
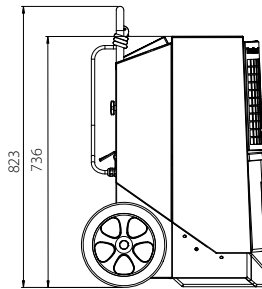

### CDT 40S

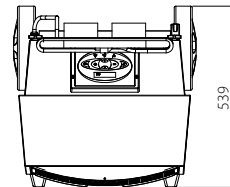
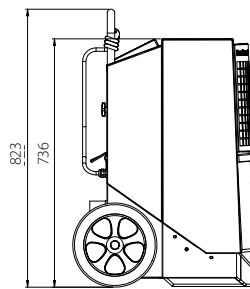

All measurements are in mm

### Performance data

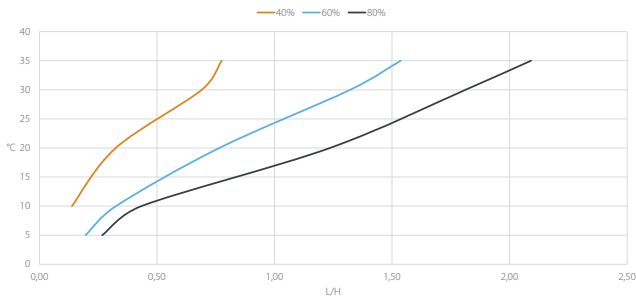

### CDT 40

#### Specific energy consumption (SEC)

0.44 kWh/l at 30°C & 80% RH

0.78 kWh/l at 20°C & 60% RH

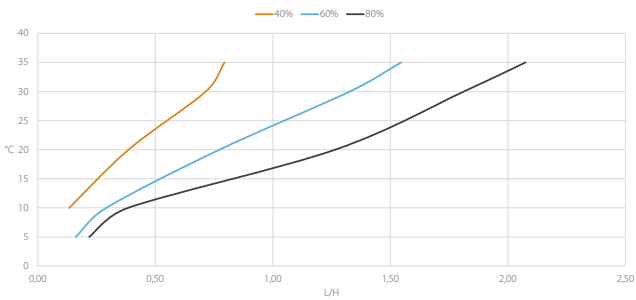

### CDT 40S

#### Specific energy consumption (SEC)

0.44 kWh/l at 30°C & 80% RH

0.77 kWh/l at 20°C & 60% RH

The active, demand-controlled defrosting is activated through a temperature sensor on the evaporator. Defrosting is done by means of hot refrigerant being fed through the evaporator.



# PORTABLE CONDENSATION DEHUMIDIFIERS

## CDT 60



**CDT 60**

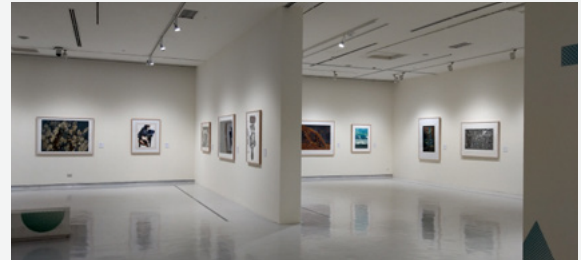

- Electronic control display
- Water container with handles
- Automatic stop when water container is full or removed
- High capacity
- Low energy consumption
- F-gas regulation 2020 compliant refrigerant
- Strong and robust cabinet of powder-coated hot galvanized steel
- Epoxy-coated evaporator with active defrosting and condenser
- Adjustable handle
- Plastic bumpers
- Low weight
- Stackable
- Big wheels
- Can be integrated with Remote Monitoring Solution from Dantherm Group

The CDT 60 is a robust, cost-effective and energy-efficient, reliable mobile dehumidifier. It works in accordance with the condensation principle. A fan draws the humid air into the dehumidifier and through an evaporator coil. When passing through the evaporator the air is cooled down to below its dew point temperature, and its content of water vapour is condensed into water, which is collected in the water container.

The active, demand-controlled defrosting is activated through a temperature sensor on the evaporator. Defrosting is done by means of hot refrigerant being fed through the evaporator.



### Optional accessories



**Hygrostat with 0.4m cable, jack plug and fitting**  
396242



**Hygrostat with 3m cable and jack plug**  
396241



**1/2" draining tap and screwed hose connector**  
396243



**Wall bracket**  
396248

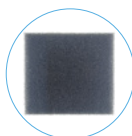

**Spare filter**  
036452



**Cassette with built-in condensate pump**  
075617

# PORTABLE CONDENSATION DEHUMIDIFIERS

## CDT 60

### Dimensions

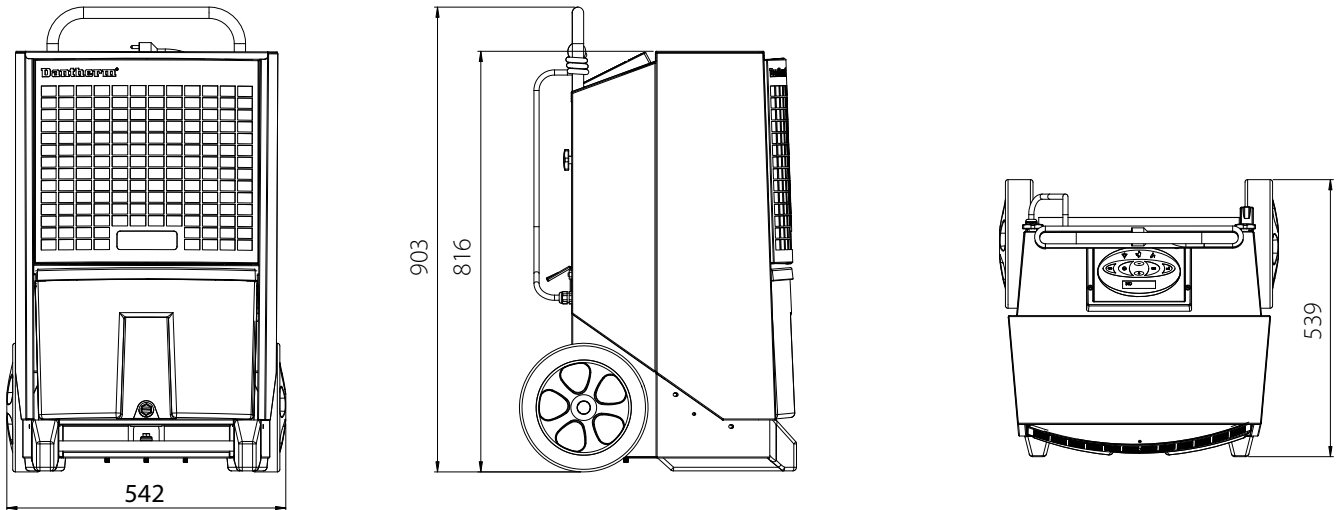

All measurements are in mm

### Performance data

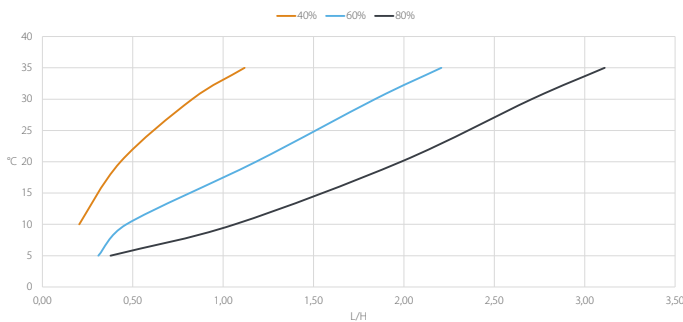

### CDT 60

#### Specific energy consumption (SEC)

0.42 kWh/l at 30°C & 80% RH

0.75 kWh/l at 20°C & 60% RH

Specifications	Units	CDT 60
Capacity (30°C/80% RH)	l/24h	65.0
Capacity (20°C/60% RH)	l/24h	28.4
Air flow	m <sup>3</sup> /h	725
Operating temperature range	°C	3-35
Operating humidity range	% RH	40-100
Max. power consumption	W	1300
Power supply	V/Hz	230/50
Sound level @1m	dB(A)	57
Refrigerant		R454c
Water tank	l	14
Protection class		IP X4
Height with handle down	mm	903
Width	mm	542
Depth	mm	539
Weight	kg	46



# PORTABLE CONDENSATION DEHUMIDIFIERS

## CDT 90



**CDT 90**

The CDT 90 is a robust, cost-effective and energy-efficient, reliable mobile dehumidifier. It works in accordance with the condensation principle. A fan draws the humid air into the dehumidifier and through an evaporator coil. When passing through the evaporator the air is cooled down to below its dew point temperature, and its content of water vapour is condensed into water, which is collected in the water container.



- Electronic control display
- Water container with handles
- Automatic stop when water container is full or removed
- High capacity
- Low energy consumption
- F-gas regulation 2020 compliant refrigerant
- Strong and robust cabinet of powder-coated hot galvanized steel
- Epoxy-coated evaporator with active defrosting and condenser
- Adjustable handle
- Plastic bumpers
- Low weight
- Big wheels
- Can be integrated with Remote Monitoring Solution from Dantherm Group



The active, demand-controlled defrosting is activated through a temperature sensor on the evaporator. Defrosting is done by means of hot refrigerant being fed through the evaporator.

### Optional accessories



**Hygrostat with 0.4m cable, jack plug and fitting**  
396242



**Hygrostat with 3m cable and jack plug**  
396241



**1/2" draining tap and screwed hose connector**  
396243



**Spare filter**  
036849

# PORTABLE CONDENSATION DEHUMIDIFIERS

## CDT 90

### Dimensions

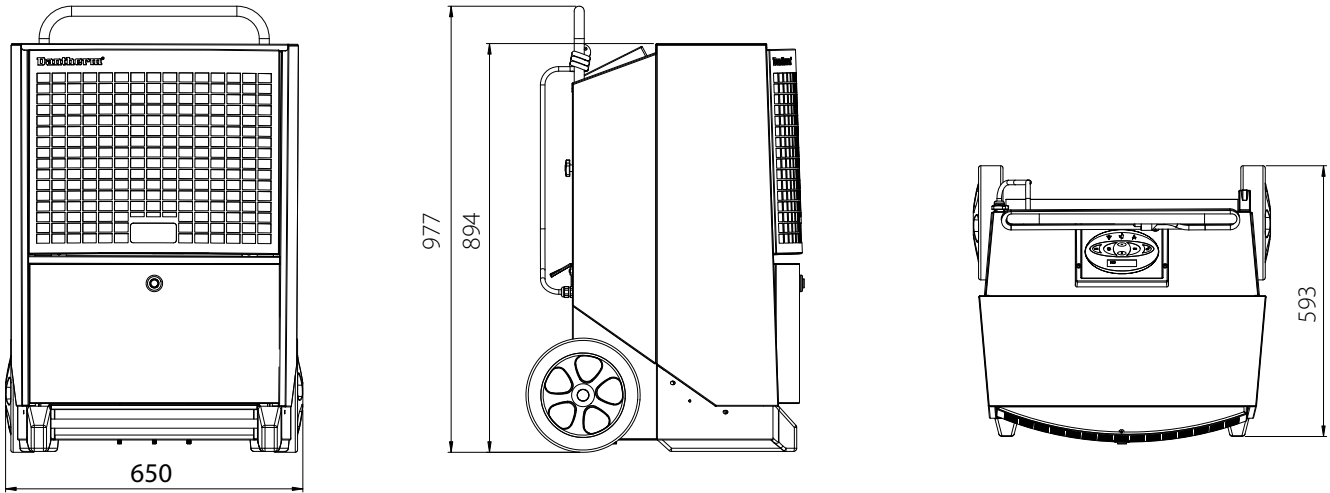

All measurements are in mm

### Performance data

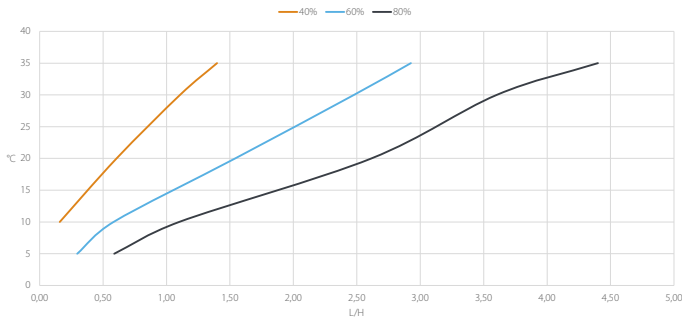

### CDT 90

#### Specific energy consumption (SEC)







0.48 kWh/l at 30°C & 80% RH

0.81 kWh/l at 20°C & 60% RH

Specifications	Units	CDT 90
Capacity (30°C/80% RH)	l/24h	86.5
Capacity (20°C/60% RH)	l/24h	37
Air flow	m <sup>3</sup> /h	1000
Operating temperature range	°C	3-35
Operating humidity range	% RH	40-100
Max. power consumption	W	1900
Power supply	V/Hz	230/50
Sound level @1m	dB(A)	57
Refrigerant		R454c
Water tank	l	drain outlet for connection to a 1/2" water hose
Protection class		IP X4
Height with handle down	mm	977
Width	mm	650
Depth	mm	593
Weight	kg	62

# ACCESSORIES

## CDT 30-30S-40-40S-60-90

Illustration	Accessory	Products	Code
	<b>Hygrostat with 0.4m cable, jack plug and fitting</b>	ALL	<b>396242</b> <b>396241</b>
	<b>Hygrostat with 3m cable and jack plug</b>		
	<b>1/2" draining tap and screwed hose connector</b>	ALL	<b>396243</b>
	<b>Remote monitoring solution Simplify Climate Solutions</b>	ALL	<b>Please contact sales for more information</b>
	<b>Condensate pump in a cassette</b>	CDT 30/30S CDT 40/40S/60	<b>075616</b> <b>075617</b>
	<b>Wall bracket</b>	CDT 30/30S CDT 40/40S/60	<b>396247</b> <b>396248</b>
	<b>Spare filter</b>	CDT 30/CDT 30S CDT 40/CDT 40S CDT 60 CDT 90	<b>035862</b> <b>035973</b> <b>036452</b> <b>036849</b>





**Dantherm A/S**

Marienlystvej 65  
DK-7800 Skive  
Denmark  
t. +45 96 14 37 00

**Dantherm Ltd.**

Unit 12, Galliford Road  
Maldon CM9 4XD  
United Kingdom  
t. +44 (0)1621 856611

**Dantherm GmbH**

Oststraße 148  
22844 Norderstedt  
Germany  
t. +49 40 526 8790

**Dantherm S.p.A.**

Via Gardesana 11  
37010 Pastrengo (VR)  
Italy  
t. +39 045 6770533

**Dantherm Sp. z o.o.**

ul. Magazynowa 5a  
62-023 Gądki  
Poland  
t. +48 61 65 44 000

**Dantherm SP S.A.**

C/Calabozos 6  
(Polígono Industrial)  
28108 Alcobendas, Madrid  
Spain  
t. +34 91 661 45 00

**Dantherm SAS**

23 rue Eugène Hénaff  
69694 Vénissieux Cedex  
France  
t. +33 4 78 47 11 11

**Dantherm AS**

Løkkeåsveien 26  
3138 Skallestad  
Norway  
t. +47 33 35 16 00

**Dantherm AB**

Fridhemsvägen 3  
602 13 Norrköping  
Sweden  
t. +46 (0)11 19 30 40

**Dantherm LLC**

Transportnaya 22/2  
142800, Stupino  
Moscow  
Russia  
t. +7 (495) 642 444 8

**MCS China**

Unit 2B, No. 512  
Yunchuan Road  
Baoshang, Shanghai, 201906  
China  
t. +8621 61486668

**AirCenter AG**

Täferstrasse 14  
CH-5405 Baden Dättwil  
Switzerland  
t. +41 43 500 00 50

**Heylo GmbH**

Im Finigen 9  
28832 Achim  
Germany  
t. +49 4202 97550

**SET Energietechnik GmbH**

August-Blessing-Straße 5  
71282 Hemmingen  
Germany  
t. +49 7150 94540

Dealer:

KEEP UPDATED  
**FOLLOW US ON:**

