

Manual

EN

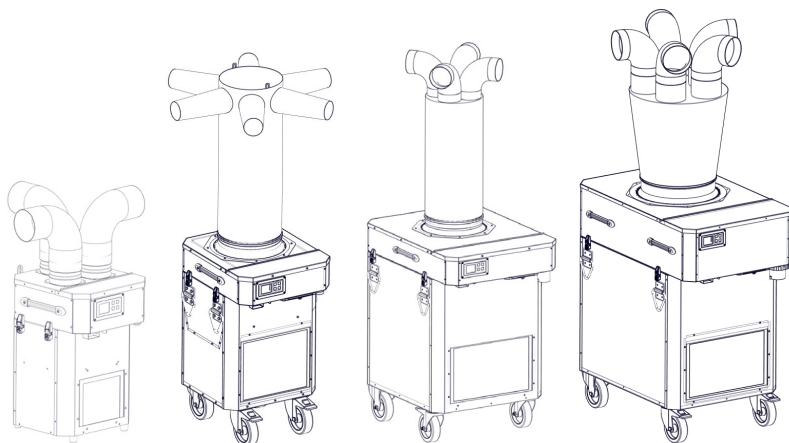

# TF 9EL, TF 18EL, TF 36EL, TF 72EL EBC



*This product is only suitable for well-insulated areas or occasional use.*

## SAFETY



Read the instruction manual carefully and ensure you understand the content before using the product.

The manufacturer guarantees that this product fulfils safety requirements in accordance with the relevant EU directives and standards.

EU Declaration of Conformity, see

[www.elbjorn.com](http://www.elbjorn.com).

### Warning signs on the product.

If these are missing they must be replaced with new ones as soon as possible. These are available from the El-Björn website.

### Safety during assembly

- If extension cables are used: Only use approved extension cables that are marked for outdoor use.
- Connect the machine to a power distribution box with a residual current device.
- Check the electrical box and electrical cables before start-up/disconnection. Replace any defective parts.
- The machine must be turned off before installing the El-Björn metal air distributor.
- Make sure the distance between the machine and the wall is at least 0.5 m.
- Do not use the machine close to showers, baths, pools etc.

### Safety during use

- The machine must always be connected to an El-Björn metal air distributor.
- The machine must never be covered during operation.
- The wheels must be locked during operation
- The cover must be fitted to the electrical box.
- The 4 lever lock fasteners must be locked with a spanner throughout operation.
- Keep the machine and working area clean.
- Do not mistreat the electrical cable. Do not jerk the electrical cable out of the electrical inlet/outlet. Do not expose it to high temperatures, oil, or sharp edges.
- Make sure the machine is standing on a firm, level surface.

- Important: Do not try to lift the machine using the carrying handle for Module 2 (heating module).
- Do not allow children under the age of 3 near the equipment unless they are constantly supervised.
- Children between the ages of 3 and 8 should only be allowed to turn the machine on/off if it is installed in its normal position and they have been instructed how to use it safely and understand the risks. Children between the ages of 3 and 8 must not be allowed to plug in, adjust or carry out maintenance on the machine.
- This equipment may be used by children aged 8 upwards and by persons with reduced physical ability, impaired judgement or mental capacity, or lack of experience and knowledge, providing that they have been shown or instructed in the safe use of the equipment and they understand the risks. Children must not play with the equipment. Children may not clean or perform maintenance on the device without supervision.

**WARNING: Parts of this equipment can get very hot and could cause burns.**

**Take special care when children or vulnerable people are present.**

### Safety during service/maintenance

The machine must be isolated from the electrical supply before servicing/maintenance.

### PERSONAL PROTECTIVE EQUIPMENT

Use a respirator and gloves when replacing the air filter Put the spent filter in a bag and close it.

### MINIMUM EXPERTISE REQUIRED

Any servicing and installation work must be performed by a qualified service technician, qualified professional or the manufacturer.

## RISK ASSESSMENT

Using spare parts or accessories that have not been recommended by El-Björn increases the risk of injury or damage to the machine.

The machine is only intended for temporary drying and heating of rooms. When using electrical machinery, basic safety regulations shall always be followed, in order to reduce the risk of fire, electric shocks, burns or other personal injury.

**Read the instructions before starting the machine and save the instructions for safe operation.**

---

## INTRODUCTION

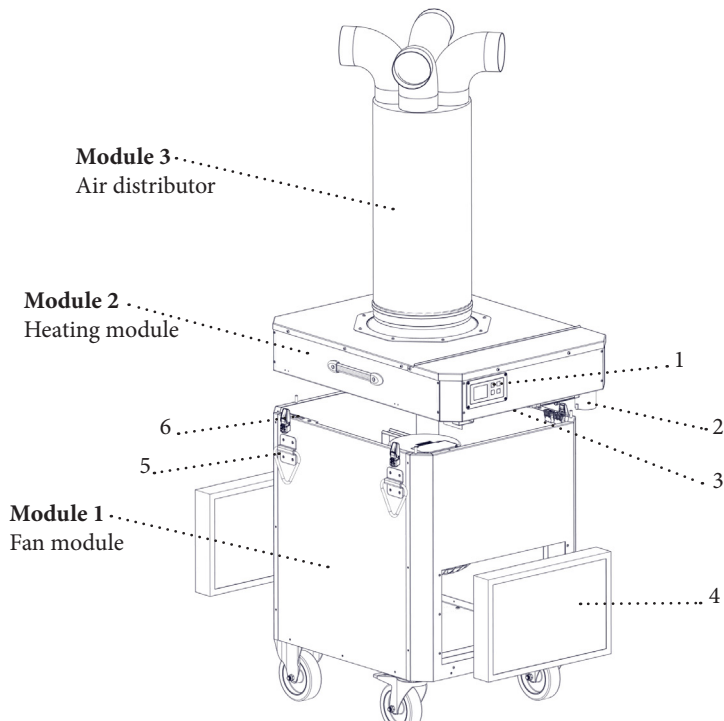

1. Display
2. Inlet
3. Fuses
4. Filter
5. Lifting eyes
6. Lever lock fastener

## DESCRIPTION

The entire product is constructed from powder-coated, corrosion-resistant, galvanized sheet steel. The machine comprises 3 main modules.

Module 1. (Fan module) includes wheels, filter, fan and lifting eyes.

Module 2. (Heating module) includes display, control card, inlet, fuses and heating element.

Module 3. Air distributor

### Module 1.

- 4 x heavy-duty wheels for moving machine, 2 of which are lockable.
- 4 x lifting eyes for moving machine or suspending it from ceiling.
- 2 x filters with additional pre-filter for extended life (TF 18EL, TF 36EL, TF 72EL).
- 1 x filter with additional pre-filter for extended life (TF 9EL).

### Module 2.

- Inlet, fuses and temperature/humidity sensors are well protected beneath overhang.
- Removable cover on top for electrical box. Accessible only by qualified service technician.
- All machine controls are provided on the display. See instructions for display.

### Module 3.

Air distributor.

The air is drawn in through two filters (one filter TF 9EL) from the front and rear of the machine (Module 1). This acts like an intake noise attenuator as air pressure builds up in the fan compartment. The air is heated (Module 2) by the heating elements and flows out through the textile air distributor (Module 3) which propels the warm, dry air over a long distance.

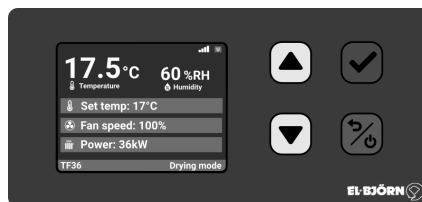

Display

# DESCRIPTION OF DISPLAY

## DESCRIPTION OF BUTTONS

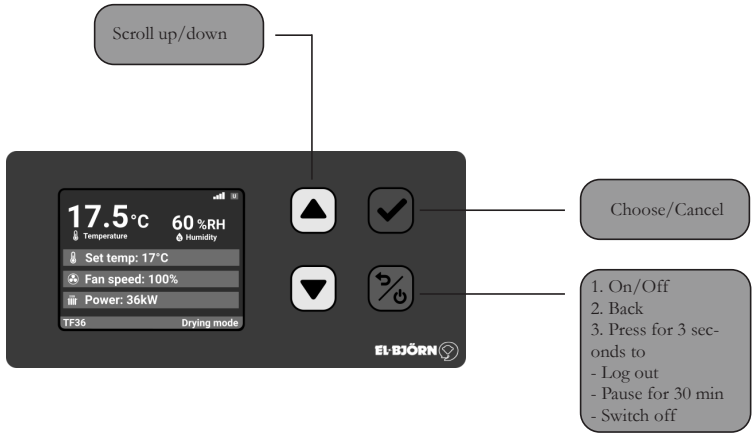

## MENU DESCRIPTION

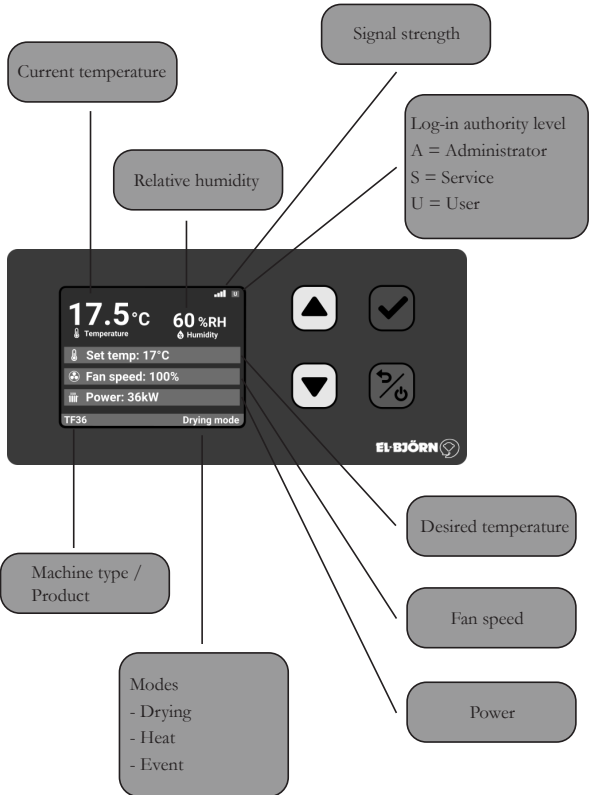

## STARTING/STOPPING THE DRYING FAN IN DRYING MODE

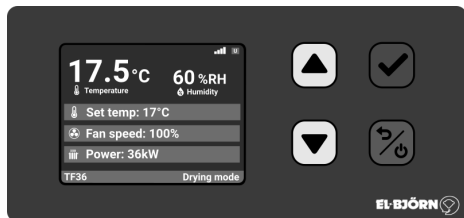

1. To turn on the display, press the RED ON BUTTON on the control panel for 1 second.
2. The above menu will appear in the display.
3. The drying fan is pre-set by default to drying mode.
4. To start the drying fan, press and hold the GREEN BUTTON for 2 seconds (the fan will start).
5. To switch off the drying fan, press and hold the RED BUTTON for 3 seconds.

The following options are available:

- Log out
- Pause drying fan for 30 minutes
- Switch off

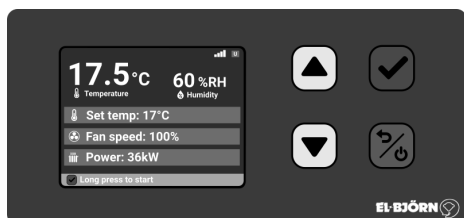

## CHANGING THE DEFAULT SETTING TO HEAT/EVENT

1. To log in, press and hold the tick button for 1 second, the window below will appear.
2. Use the arrows to enter your password, and press the GREEN button to confirm.
3. There are two levels of authorisation: Administrator and Service.  
(If no change is made to the display within 60 seconds you will be logged out automatically.)
4. To access the various menu options, press the RED button for 1 second and the window below will appear.
5. Use the arrows to select the default mode, then confirm by pressing the GREEN button.

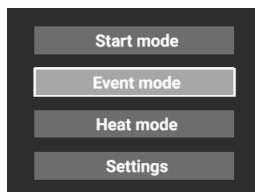
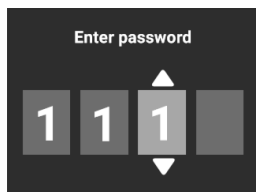

## CHANGING DEFAULT SETTINGS

### DESIRED TEMPERATURE, FAN SPEED, POWER (ELECTRIC DRYING FAN)

1. To log in, press and hold any button for 1 second, the window below will appear.
2. Use the arrows to enter your password, and press the GREEN button to confirm.
3. There are two levels of authorisation: Administrator and Service.  
(If no change is made to the display within 60 seconds you will be logged out automatically.)

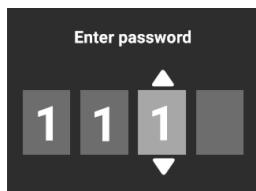

4. To change the default settings, press the up arrow up or down arrow to choose a setting. The chosen setting will then be highlighted in orange.
5. To change the selected setting, press the GREEN button to confirm.
6. Use the up/down arrows to adjust the desired setting, then press the GREEN button to confirm.

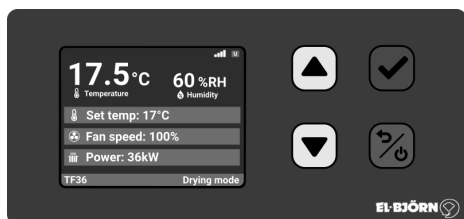

## LIST OF ALARMS



### Filter pressure

Filter pressure out of limits

Time to replace filter:

- To cancel the alarm, press the green button
- The alarm symbol will shrink, but will stay on until the filter is replaced



### Overheating

Output temperature too high

The product has overheated for some reason



### Power loss

Machine was shutdown improperly

The product has not been switched off correctly:

- Power cut
- Power cord failure
- Fuse has tripped



### Fan alarm

Fan fault

Electrical fault in fan



### Antifreeze

Water temperature too low

Frost guard, water temperature below critical level, risk of heat exchanger freezing. The fan stops if the water temperature drops below 6 degrees Celsius, and restarts automatically when the water temperature rises above 15 degrees Celsius.



### Humidity

Humidity too high

Indication that relative humidity of surroundings is above 50%



### Temperature

Temperature set out of limits

Temperature is outside pre-set temperature range



## TECHNICAL DATA

	TF 9EL 400 VAC	TF 18EL 400 VAC	TF 36EL 400 VAC	TF 72EL 400 VAC
H incl. air distributor	940	2150mm	2150 mm	2200 mm
H excl. air distributor	700	1000mm	1200 mm	1400 mm
W	440mm	560mm	740 mm	740 mm
D	460mm	640mm	935 mm	1110 mm
Total weight (top section, bottom section, distributor)	32,5kg (16) (16,5)	66kg (23,5) (42,5)	127.5 kg (41.5) (77.5) (8.5)	180 kg (72) (96.5) (11.5)
Noise level	61/54	62/57 dB(A)	68/63 dB(A)	69/63 dB(A)
Rated current	13A	27A	57 A	110 A
Rated voltage	3N~400V	3N~400V	3N~400 V	3N~400 V
Encapsulation class	IP 44	IP 44	IP44	IP44
Seasonal average efficiency ( $\eta_s$ )	36%	36%	36%	36%
<b>Motor and air side</b>				
Fan voltage	1N~230V	1N~230V	3N~400 V	3N~400 V
Fan power	170W	500W	1700 W	4500 W
Fan current	1,4A	2,2A	2.6 A	7.0 A
Air flow	1500/1000m <sup>3</sup> /h	2500/2040m <sup>3</sup> /h	4650/3850 m <sup>3</sup> /h	7900/6454 m <sup>3</sup> /h
Temperature rise	38/25	22/23°C	29/34°C	40/47°C
<b>Electric heating</b>				
Electric elements	6x1,5kW	6x3kW	6 x 6 kW	12 x 6 kW

EU Declaration of Conformity, see [www.elbjorn.com](http://www.elbjorn.com).

**NOTE!**

The section concerning safety must be read and understood by everyone who uses or repairs this machine. The instructions describe operation and maintenance measures that can be performed by the operator. More detailed maintenance or troubleshooting may only be performed by a qualified professional or the manufacturer. The instructions describe all necessary safety features and must be read and understood by the user before connecting the machine to the electrical supply. In other words, the first action after delivery is to read through the operating instructions.

There are symbols and warning labels on the machine that are mentioned in the section on "Safety". If any of the warning signs on the machine have become damaged or worn, new signs must be ordered and fitted as quickly as possible in order to ensure the greatest possible safety when using the machine.

The machine may only be used for the purposes described in this instruction.

The manufacturer reserves the right to make changes.

**APPLICATION AREA**

The TF model is intended for drying and heating buildings where there is a need for temporary heating, drying or air circulation. This model is not intended for use in the presence of extremely fine particles, such as during ice blasting, in textile or carpentry shops, stables or agriculture.

**INSTALLATION****CHECK BEFORE USE**

That the machine is protected by a residual current device.

That the filter is fitted and is clean and undamaged.

That cables and connectors are undamaged and in good condition.

That the metal air distributor is correctly connected and unobstructed.

That the wheels are locked.

Check that the machine is positioned at least 0.5 m away from the wall.

That the machine always stands on a firm, level surface.

**INSTALLATION**

In order to achieve the best drying and heating performance, the machine should be positioned as centrally in the room as possible. The machine must run continuously in order to achieve optimal results. Minimum distance from wall: 0.5 m. The machine should only be used upright, with its wheels/feet at the lowest point. If the machine is to be suspended, use the 4 lifting eyes provided on

the sides of Module 1. Check that these are not damaged or deformed. The lifting eyes are only designed to support the weight of the machine itself.

**TF 9EL EBC:** Position the machine in its designated place. Connect the El-Björn metal air distributor. Connect the power cable to a fused 5-pin 16 A socket that is protected by a residual current device.

**TF 18EL EBC:** Position the machine in its designated place. Lock the wheels on the machine. Connect the power cable to a fused 5-pin 32 A socket that is protected by a residual current device.

**TF 36EL EBC:** Position the machine in its designated place. Lock the wheels on the machine. Connect the El-Björn metal air distributor. Connect the power cable to a fused 5-pin 63 A socket that is protected by a residual current device.

**TF 72EL EBC:** Position the machine in its designated place. Lock the wheels on the machine. Connect the El-Björn metal air distributor. Connect the power cable to a fused 5-pin 125 A socket that is protected by a residual current device.

## OPERATION

### HANDLING DURING NORMAL OPERATION

#### Start & stop

See the display instructions.

#### Adjusting the indoor temperature

See the display instructions.

#### Replacement of filter

- Replace the filter when the filter alarm appears. The filter must be fitted so that the arrow on the filter points inwards towards the machine. Always use original filters from El-Björn.
- Turn off the machine using the display and replace the filter.
- Restart the machine.

**NOTE!** Use a respirator and gloves when replacing the air filter. Put the spent filter in a bag and close it.

### HANDLING DURING ABNORMAL OPERATION

Check that the fuses in the nearest electrical cabinet have not blown and that the residual current device has not tripped.

Check the fuses inside the machine.

Resetting the overheating protector. See instructions for display.

Restart the machine when it has cooled down. The motor protector is reset automatically. If this does

#### Cooling down

#### IMPORTANT!

The heating elements get very hot (about 300°C), so it is vital that the machine is switched off correctly. By switching off the machine from the display it ensures the heating elements are cooled down quickly and extends the life of the machine. This must be done every time the machine is turned off prior to filter replacement or before the machine is moved. See instructions for display.

---

## DEINSTALLATION

Turn off the machine according to the display instructions. (This extends the life of the machine). Disconnect the electrical cable. The machine can now be transported.

---

## SERVICE

### MAINTENANCE

Day-to-day maintenance should be performed on site by an appointed operator.

**NOTE!** After the first season of use it is especially important to tighten electrical connections, the fan motor mounting and heating element nuts and connections.

#### Warning!

To eliminate the risk of injury, always disconnect from the electrical supply before starting any service work. The following points must be checked by the operator.

- Keep the machine in good condition by servicing it regularly.
- Before using the machine, always check the operation of the main components (contactor, fan and heating elements).
- Check and tighten the heating elements.
- Check and tighten electrical connections on the machine.
- Check that there are no loose screws and that all parts are properly attached.
- Make sure there are no defective parts that could compromise safety.
- In the event of abnormal noise or vibrations, switch off the machine immediately and make sure the fault is repaired.
- Replace the filter when the filter alarm appears.
- Never use a machine that is damaged.
- Always mark a defective machine with “Not to be used” until it has been repaired.

## Cleaning

- Always replace the filter after use.
- Clean externally with a mild soap solution and a damp cloth. The display can be cleaned with glass cleaner and a soft cloth.
- Air-blow the inside of the machine carefully, then wipe with a damp cloth.
- Never use inflammable or combustible solvents near the machine.

## NOTE!

**All repairs to electrical parts must be performed by a qualified professional or the manufacturer.**

## TROUBLESHOOTING/CHECK LIST

### The machine does not start

- Check that the fuses in the nearest electrical cabinet are intact.
- Check whether the residual current device in the nearest electrical cabinet has tripped.
- The machine has overheated and cannot be restarted until the temperature has dropped.
- Check whether the fuses in the machine have tripped. These are located beneath the inlet behind the fuse cover.

### The machine emits too little air

- Check that the air distributor/vents are not blocked.
- Check that the air inlet and filter are not clogged.
- See the display instructions.

### There is no hot air supply

- Check that the correct drying program has been selected.
- Check whether the fuses have tripped. These are located beneath the inlet behind the fuse cover.
- Check whether the overheating protector has tripped. The display will show a red warning.

If this fault occurs, contact a qualified professional or the manufacturer.

---

## TRANSPORTATION/STORAGE

The machine must always be transported upright. Before transporting the machine, fix the air distributor in its lowered position if necessary. During transportation, the machine must be anchored to the transport vehicle. The machine should only be lifted using the 4 lifting eyes on the sides of Module 1. When the machine is not in use, store it indoors where it is dry and there is no risk of freezing.

## SCRAPPING



Take the machine to a recycling station according to state or local regulations.

## WARRANTY

El-Björn AB's products and deliveries are regulated by Standard Agreement NL 09. Under these provisions, El-Björn AB is responsible for faults arising within one year from delivery.

The provisions of NL 09 also apply for professional parties who register according to the instructions below, although with the following modification:

El-Björn AB is liable for faults arising within five years after delivery; this only applies to products registered on the website.

In other respects, the provisions of NL 09 apply.

To obtain this extended warranty, you must register within 14 days from the date of purchase of the products.







**El-Björn UK LTD**

Unit 2 Oyster Park, 109 Chertsey Road, West Byfleet, GB-Surrey, KT14 7AX  
Phone: (+44) 01483 729 348, E-mail: [info@elbjorn.com](mailto:info@elbjorn.com)

**El-Björn AB**

Box 29, SE-334 21 Anderstorp, Sweden, +46 (0)371-588 100  
[info@elbjorn.se](mailto:info@elbjorn.se), [www.elbjorn.com](http://www.elbjorn.com)

