



Body Worn Camera
USER MANUAL

Preface

Welcome to the world of Hytera and thank you for purchasing this product. To derive optimum performance from the product, please read this manual carefully before use.

This manual is applicable to the following product:

[VM580D Body Worn Camera](#)

Icon Conventions

The instructional icons and their respective meanings are listed below:

 **NOTE:** Indicates references that can further describe the related topics.

 **CAUTION:** Indicates situations that could cause data loss or equipment damage.

Key Operations

- Long press: To press and hold the key for two seconds.
- Press: To press a key and release it immediately.
- Press and hold: To press a key and keep holding it down.

Copyright Information

Hytera is the trademark or registered trademark of Hytera Communications Corporation Limited (the Company) in PRC and/or other countries or areas. The Company retains the ownership of its trademarks and product names. All other trademarks and/or product names that may be used in this manual are properties of their respective owners.

The product described in this manual may include the Company's computer programs stored in memory or other media. Laws in PRC and/or other countries or areas protect the exclusive rights of the Company with respect to its computer programs. The purchase of this product shall not be deemed to grant, either directly or by implication, any rights to the purchaser regarding the Company's computer programs. Any of the Company's computer programs may not be copied, modified, distributed, decompiled, or reverse-engineered in any manner without the prior written consent of the Company.

Disclaimer

The Company endeavors to achieve the accuracy and completeness of this manual, but no warranty of accuracy or reliability is given. All the specifications and designs are subject to change without notice due to continuous technology development. No part of this manual may be copied, modified, translated, or distributed in any manner without the express written permission of us.

We do not guarantee, for any particular purpose, the accuracy, validity, timeliness, legitimacy or completeness of the Third Party products and contents involved in this manual.

If you have any suggestions or would like to learn more details, please visit our website at:

<http://www.hytera.com>.

EU Regulatory Conformance

As certified by the qualified laboratory, the product is in compliance with the essential requirements and other relevant provisions of 2014/53/EU.

- 2006/66/EC
- 2011/65/EU
- 2012/19/EU
- 2014/53/EU

Please note that the above information is applicable to EU countries only.

1. Packing List

Please unpack carefully and check that you have received the following items. If any item is missing or damaged, contact your dealer.

Item	Qty (PCS)	Item	Qty (PCS)
VM580D Body Worn Camera (BWC)	1	USB Cable	1
Battery	1	User Manual	1
Belt Clip	1	/	/



NOTE

Pictures in this manual are for reference only.

2. Product Overview

2.1 Product Layout

NOTE

- Press the Mode key to enter or return to the application interface.
- Long press the Mode key during a call to end the call.

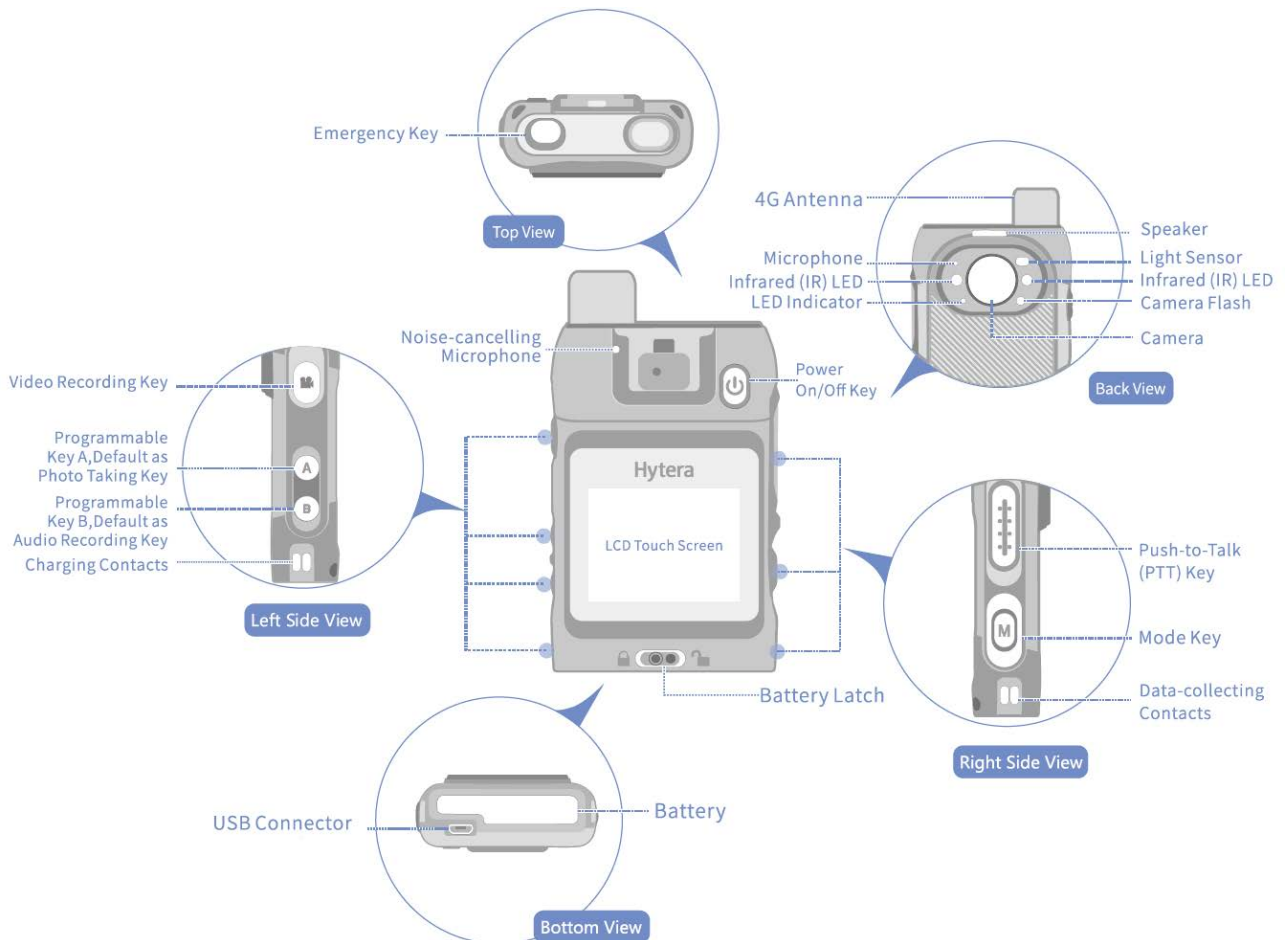

2.2 Programmable Keys

This product provides programmable keys A and B for convenient use. You can program them with the functions you need. For details, consult your dealer. The programmable functions and operations are described below.

Key	Press (Default)	Long Press (Default)	Programmable Functions
A	Take photo	Tag an audio or video	Take photo, record audio, tag an audio or video, turn on or turn off the camera flash, turn up or turn down the volume, enable or disable the silent mode, pull video by one touch.
B	Record audio	Turn or turn off the camera flash	

2.3 LED Indicator

Color	Status	Meaning
Red	Glowing	<ul style="list-style-type: none"> ● The product is transmitting audio signal. ● The battery is being charged. ● Glowing for three seconds: The storage of the TF card is full. ● Glowing for two seconds: The product is being turned off.
	Flashing	<ul style="list-style-type: none"> ● Flashing once every one second: The product is recording a video. ● Flashing once every five seconds: The battery power runs out. Recharge or replace the battery.
Green	Glowing	<ul style="list-style-type: none"> ● The battery is fully charged. ● The product is being turned on.
	Flashing	The product has unread messages.
Blue	Glowing	The product is switching to the upgrade mode.
Orange	Flashing	<ul style="list-style-type: none"> ● Flashing twice every one second: The remaining space of the TF card is less than 2 GB. ● Flashing once every one second: The product is recording an audio.

3. Before Use

3.1 Attaching the Nano SIM Card

Attach the Nano SIM card according to the following figure.

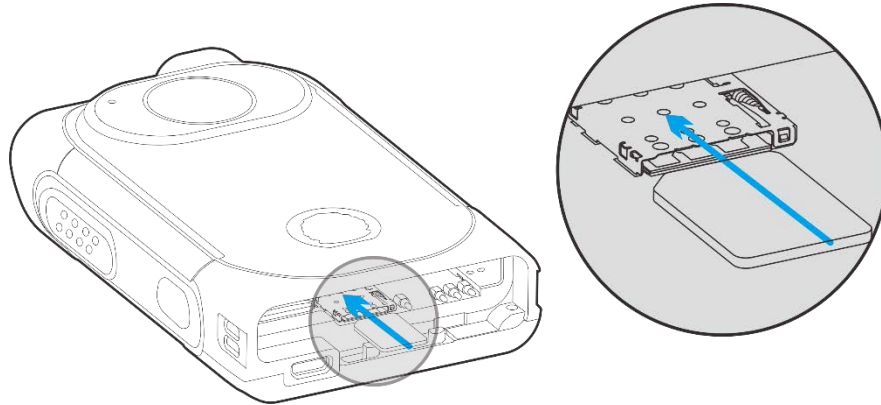

3.2 Attaching the Battery



Use only the Hytera standard or optional battery. Polarity reverse or use of other batteries may result in explosion and fire hazards.

Attach the battery according to the following figure.

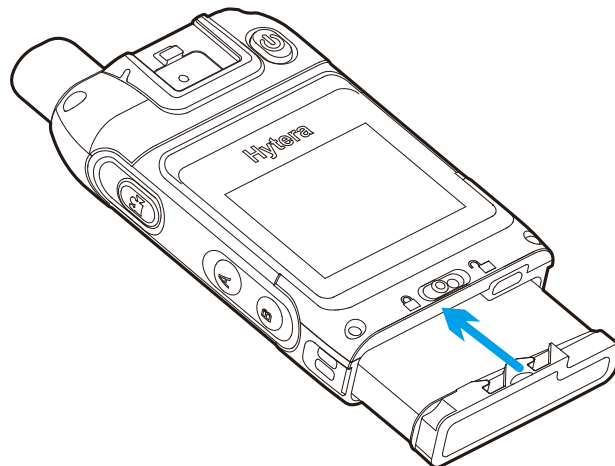

To remove the battery, turn off the product first. Push the battery latch to the bottom till the battery pops out, and then remove the battery.

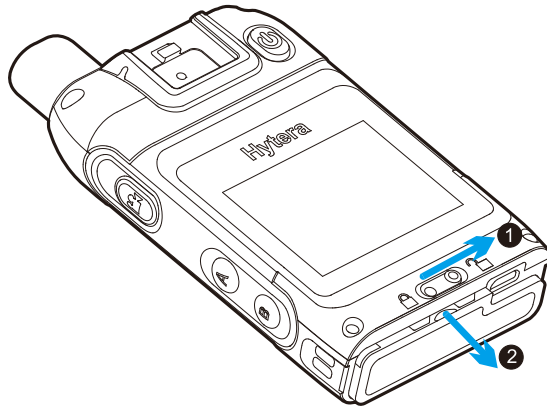

3.3 Attaching the Belt Clip

Attach the belt clip according to the following figure.

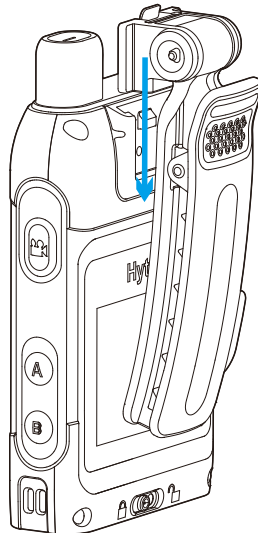

To remove the belt clip, do as follows. Toggle the metal dome, and then remove the belt clip upwards.

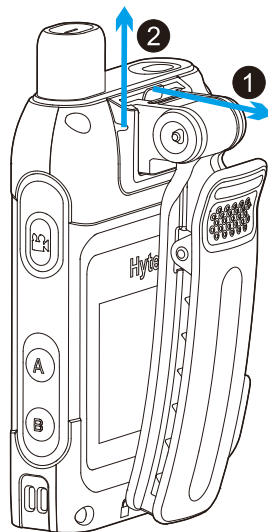

3.4 Charging the Battery

When the LED indicator on the product flashes red once every five seconds, the product is running out of power. You need to charge the battery.

You can learn the charging status from the LED indicator. For details, see 2.3 LED Indicator.

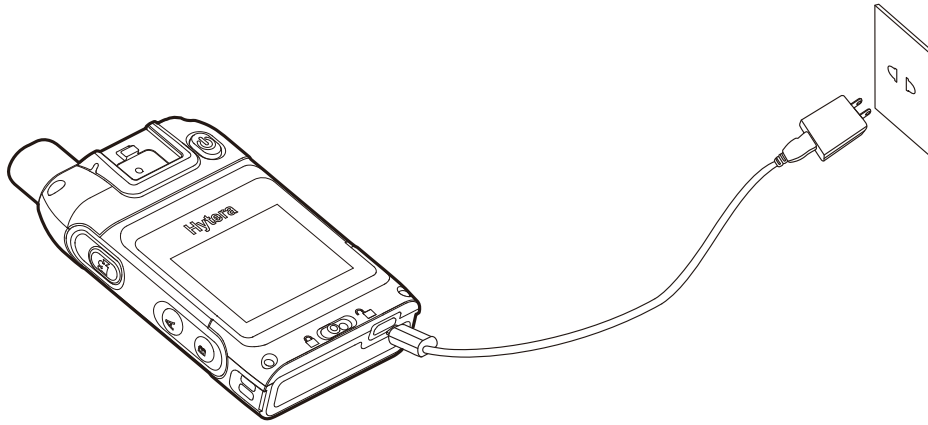

4. Basic Operations

4.1 Turning On or Off the Product

Turning On the Product

In power-off mode, long press the Power On/Off key to turn on the product and enter the preview mode.

Turning Off the Product

In power-on mode, long press the Power On/Off key to turn off the product.

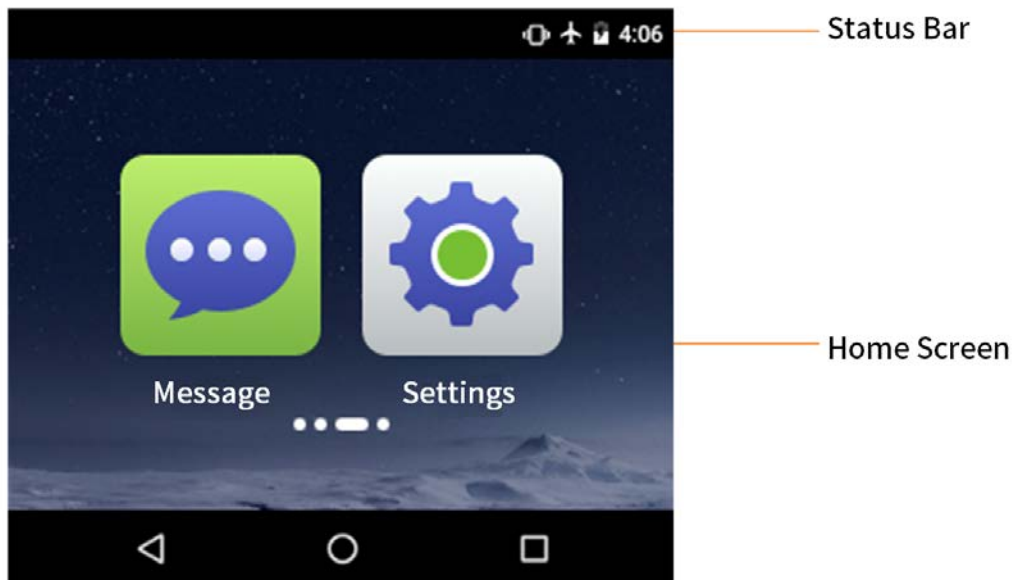

4.2 Understanding the Screen



4.2.1 Status Display

The status bar displays the notifications and running status of the product in real-time. Common status icons are described in the following table.

Icon	Description	Icon	Description
	WLAN hotspot is enabled.		WLAN connection is established.
	Location service is enabled.		Cellular network is enabled.
	BT feature is enabled.		No SIM card is inserted.
	BT connection is established.		The battery power is full.

Icon	Description	Icon	Description
	Airplane mode is enabled.		The battery is being charged.

4.2.2 Notifications and Shortcuts

New notifications display shortly on the top of screen, or display constantly in the middle of screen till you acknowledge it. On the main screen, swipe down from the status bar to open the notification center, where you can adjust brightness, turn on or turn off shortcut switches, open settings, and view or clear notifications.

4.2.3 Sleep and Wakeup

Sleep

When the sleep time is up, the product enters sleep mode automatically. In power-on mode, press the Power On/Off key to enter sleep mode. You can also set the sleep time in Settings > System > Sleep.

Wakeup

When the screen goes off, press the Power On/Off key or the Mode key to wake up the screen.

4.3 Connecting to the Internet

4.3.1 Cellular Network



Before enabling the cellular network, confirm that the SIM card has registered to the carrier networks. If you are not using the cellular network, disable the cellular network to save data cost and extend the standby time.

4.3.2 WLAN

By connecting to a WLAN (Wireless Local Area Networks), the product can connect to the server, and realize functions such as making or receiving a voice call, and sending or receiving messages including text, status or multimedia.

To use the WLAN, do one of the following:

- Enable WLAN through the shortcut.
 - a. Swipe down from the status bar to display all shortcut switches. Tap  to enable WLAN.
 - b. Select an available network from the WLAN list.

- c. (Optional) If the network displays with a  icon, enter the password and then tap Connect.
- Enable WLAN through Settings.
 - a. In the home screen, tap Settings > Network > WLAN, and then enable the WLAN.
 - b. Select an available network from the WLAN list.
 - c. (Optional) If the network displays with a  icon, enter the password and then tap Connect.

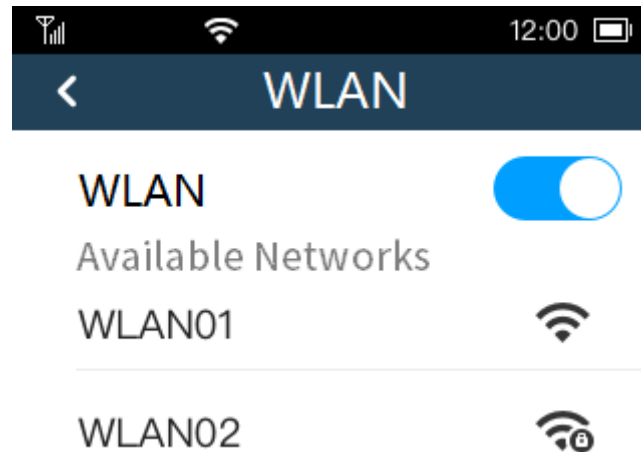

The product automatically saves WLAN information upon successful connection, and automatically connects to the saved network when WLAN is switched on and the network is available.

5. System Settings

Tap Settings on the home screen, and enter the Settings. Set the parameters according to your actual needs.

Setting		Description
Account		View the user name, user ID, organization name and organization ID.
Network	WLAN	Enable or disable the WLAN, view the available networks, connect to a network and enter the password. After successful WLAN connection, you can visit the Internet or shared media from other devices in the network.
	WLAN Hotspot	Set the WLAN hotspot, SSID, security and access password. After enabling the WLAN hotspot, you can share the cellular network with other devices.
	BT	After BT connection with other devices, you can transmit data through BT over short distances.
	Cellular Network	Enable or disable the cellular network.
Multimedia	Video Resolution	The resolution of recorded video. High resolution indicates larger video file size. The options include 1080P 30 fps, 720P 30 fps and 480P 30 fps.
	Pre-recording Time	Pre-recording allows the product to automatically capture a period time of footage prior to an event that leads you to start video recording. The options include Off, 10 sec, 20 sec and 30 sec.
	Post-recording Time	Post-recording can add a period time of footage after the recording is deactivated. The options include Off, 10 sec, 20 sec and 30 sec.
	Strike Sensibility	By setting the strike sensibility, upon detecting certain acceleration of movement of itself, the BWC automatically starts video recording.

Setting		Description
		The options include Off, Low, Medium and High.
	Video Split Time	<p>Split time defines the maximum time length of a single audio or video recording. When the product starts audio or video recording and reaches the split time, a recording file will be saved automatically and the product starts a new timing again, and then loops the process.</p> <p>The options include 5 min, 10 min and 15 min.</p>
	Photo Resolution	<p>The resolution of photos. High resolution indicates larger photo file size.</p> <p>The options include 16 MP, 5 MP and 3 MP.</p>
	Photo Quality	<p>Photo quality refers to the compression ratio of the photo. Under the same resolution, higher photo quality indicates lower compression ratio and bigger size; lower photo quality indicates higher compression ratio, and smaller size.</p> <p>The options include Normal, High and Ultra High.</p>
	Night Vision	<p>With this feature enabled, the IR LED will light up when the product is recording video in the dark.</p> <p>The options include On, Off or Auto.</p>
PTT	Emergency Call Priority	<p>The default method to initiate the emergency call.</p> <p>The options include Half-duplex voice individual call and Voice group call.</p>
	Emergency Number	The default called party that you initiate an emergency call to.
System Settings	Airplane Mode	You may be required to turn off the BWC or set the BWC to airplane mode when you are in an airplane or in an area with radio restrictions. In airplane mode, the product automatically disables cellular network and WLAN, so that you cannot use voice, video or data related services. With the permission of the airline company,

Setting		Description
	Brightness	Adjust the screen brightness automatically or manually. With auto-brightness enabled, the product automatically adjusts the screen brightness according to the environmental brightness over the light sensor for optimal experience.
	Sleep	If no operation is made to the product within the preset sleep time, the screen automatically goes off to save battery power. The options include Never, 10 sec, 20 sec, 30 sec.
	Volume	Adjust the volume of the media or ringtone.
	Language	Choose the display language of the interfaces.
	Notification	Set the new message alert method.
	Antibanding	When the product is used under indoor fluorescent lamp, the LCD screen may have flickers or stripes during video and photo shooting because of the frequency disparity between the light sensor exposure and the local AC power. To fix the flickers, set the antibanding to Auto, and then the product will adjust the flickers automatically. The options include 50 Hz, 60 Hz or Auto.
	Location Service	Whether to enable the location service.
	Silent Mode	In silent mode, the product gives no alarms or rings; its indicators and screen go dim to keep the product in concealment.
About		View the device name, device ID, SN, storage capacity, software version, application version and certification information.

6. Basic Functions

The product can only enable voice, video and message services through the communication system. Use the BWC Manager to configure the product number and system parameters. The contacts and other information can be automatically synchronized through the network. For details, refer to the related documents.

6.1 Recording a Video

When the product is in emergency mode or triggers strike recording, it automatically starts video recording. During the recording, you can still use the product to view or initiate calls and send messages.

- Normal recording: In preview mode, press the Video Recording key to start video recording; the LCD screen displays the recording time. During video recording, press the Video Recording key again to finish recording.
- Pre-recording allows the product to automatically capture a period time of footage prior to an event that leads you to start video recording.
- Post-recording adds a period time of footage after the recording is deactivated.
- Tagged Recording: During video recording, long press the Photo Taking key to tag the video as key evidence or untag the tagged video.

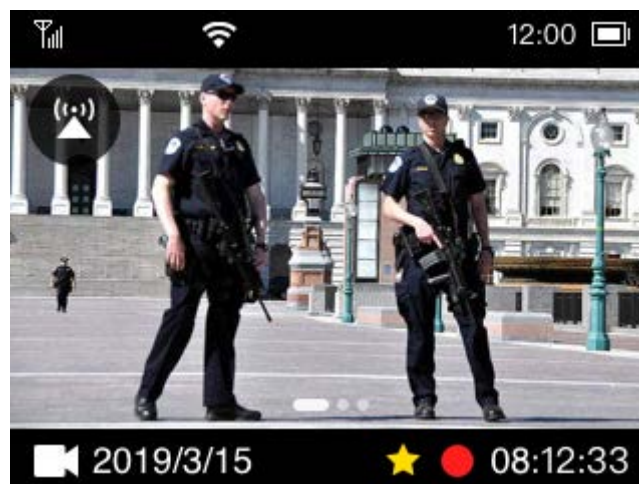

6.2 Recording an Audio

During audio recording, you can still use the product to view or initiate calls and send messages.

- Normal recording: In preview mode, press the Audio Recording key to start audio recording; the LCD screen displays the recording time. During audio recording, press the Audio Recording key again to finish recording.

- Tagged Recording: During audio recording, long press the Photo Taking key to tag the audio as key evidence or untag the tagged audio.



6.3 Taking a Photo

In preview mode, press the Photo Taking key to take a photo.



6.4 Taking a Photo during Video Recording

During video recording, press the Photo Taking key to take a photo.

6.5 Flashlight

Long press the Audio Recording key to turn on the flashlight. Long press the Audio Recording key again to turn off the flashlight.

6.6 Emergency Mode

- Enabling emergency mode: In emergency situations, press the Emergency key to enable the emergency mode. With a voice prompt of the emergency mode, the product starts key video recording, and sends an emergency alarm message to the dispatcher to seek for help.

You can set the dispatcher number from the NM8000. Upon receiving the message, the dispatcher pulls the video and starts a voice call with the product.

- Disabling emergency mode: In emergency mode, long press the Emergency key to disable the emergency mode. The product will stop key video recording.

6.7 Group Call

A group call is a one-to-many half-duplex voice call or one-way video call between a BWC and all members in a group. During the group call, only one group member can talk in the same time, while other groups members can only listen.

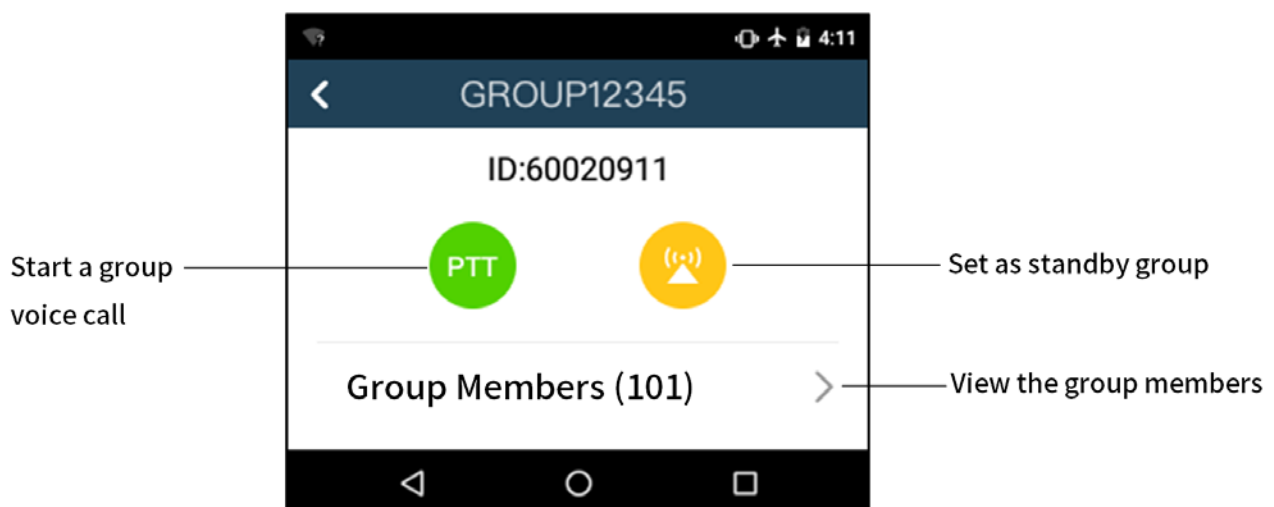

6.7.1 Answering a Group Call

You can answer a group call without making operations.

6.7.2 Initiating a Group Call

You can initiate a group call by either of the following methods:

- In the Recent tab of the contacts, tap a group call number in the records and initiate a half-duplex group voice call.
- In the Group tab of the contacts, tap a group call number from the list and initiate a group call according to the actual needs.
- Press the PTT key to initiate a half-duplex group voice call to the standby group by default.
- In the Message interface, tap a group call number in the records and then tap  in the upper right corner. Initiate a group call according to the actual needs.

6.7.3 Requesting or Releasing Floor

Press and hold the PTT key to request floor and speak to the microphone; release the PTT key to release the floor.

6.7.4 Ending a Group Call

Tap  to end a group call.

6.8 Individual Call

An individual call is a one-to-one half-duplex voice call between two BWCs or a BWC and a line dispatch station (LDS). In a half-duplex voice call, only one party can speak at the same time; when one party is speaking, the other party can only listen.

In the contact list, select the contact, and tap PTT or press the PTT key to initiate a call.

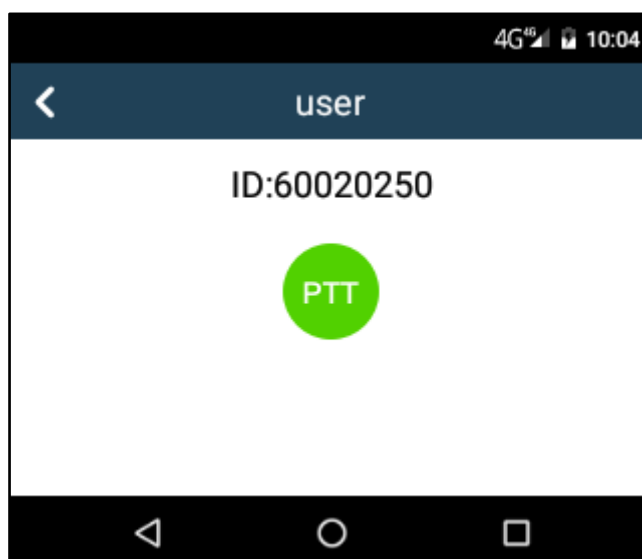

6.8.1 Answering an Individual Call

You can answer an individual call by either the Full Off Air Call Set-Up (FOACSU) mode or the Off Air Call Set-Up (OACSU) mode.

- FOACSU Mode: Tap  or press the PTT key to answer an individual call.



- OACSU Mode: You can answer an individual call without making operations.

6.8.2 Initiating an Individual Call

You can initiate an individual call by either of the following methods:

- In the Recent tab of the contacts, tap an individual contact number in the records and initiate an individual call.
- In the Individual tab of the contacts, tap an individual contact number from the list and initiate an individual call according to the actual needs.
- In the Message interface, tap an individual contact number in the records and then tap  in the upper right corner. Initiate an individual call according to the actual needs.

6.8.3 Requesting or Releasing Floor

You can only request or release the floor in half-duplex voice calls.

Press and hold the PTT key to request floor and speak to the microphone; release the PTT key to release the floor.

6.8.4 Ending an Individual Call

Tap  to end an individual call.

6.9 Broadcast Call

A broadcast call is a one-way voice call initiated by an LDS to a group. The group members can only listen, but cannot speak.

6.10 Emergency Call

An emergency call is a call initiated by the BWC or LDS to the designated individual or group

number to call for help in case of emergencies. With the highest priority, the emergency call can interrupt any calls of lower priority.

6.10.1 Answering an Emergency Call

You can answer an emergency call without making operations.

6.10.2 Initiating an Emergency Call



Set the emergency call priority and the emergency number in Settings > PTT.

In the home screen, tap  to initiate an emergency call to the emergency number according to the priority settings.

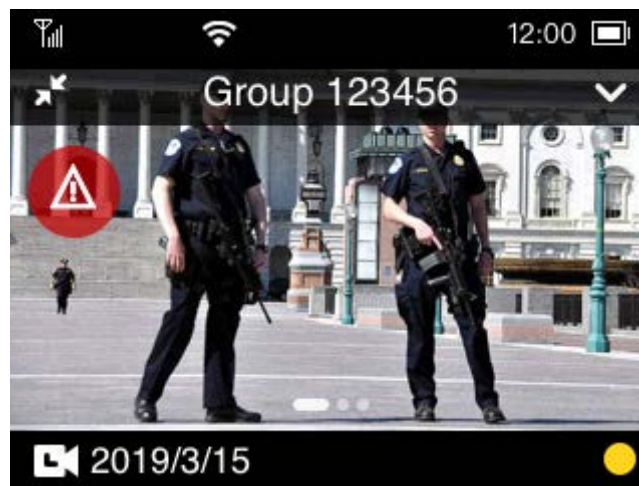

6.10.3 Requesting or Releasing Floor

Emergency half-duplex individual voice call or emergency group voice call: Press and hold the **PTT** key to request floor and speak to the microphone; release the **PTT** key to release the floor.

6.10.4 Ending an Emergency Call

Tap  to end an emergency call.

6.11 Video Pulling

By video pulling, the LDS initiates a one-way video call to the BWC, and pulls the video of the BWC to the LDS.

6.12 DGNA

In a dynamic group number assignment (DGNA), the dispatcher can group the BWCs temporarily.

When a dynamic group is created, the dispatcher and the group members of the dynamic group can initiate half-duplex voice calls to the dynamic group.

6.13 Late Entry

If the BWC or the LDS initiate a voice call to a group, and a radio in the group is not registered or has other ongoing services, when the radio registers successfully or finishes the ongoing service, it will be pulled to the group call.

6.14 Group Call Inclusion

This feature allows the system to merge the subscriber, who initiates a call to a group with an ongoing call, into this group as a called member.

7. Message

You can only receive new message on this product.

Message includes two categories: status message and multimedia message. The status message is a user-defined status code. The multimedia message includes image, video, audio and other files.

1. Tap the Message icon from the home screen, and then enter the message interface.

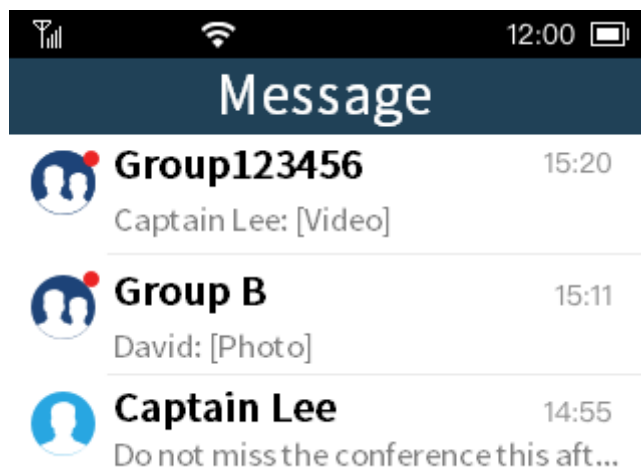

2. Tap an unread message and then view the message. You can also view all historical messages with the sender.

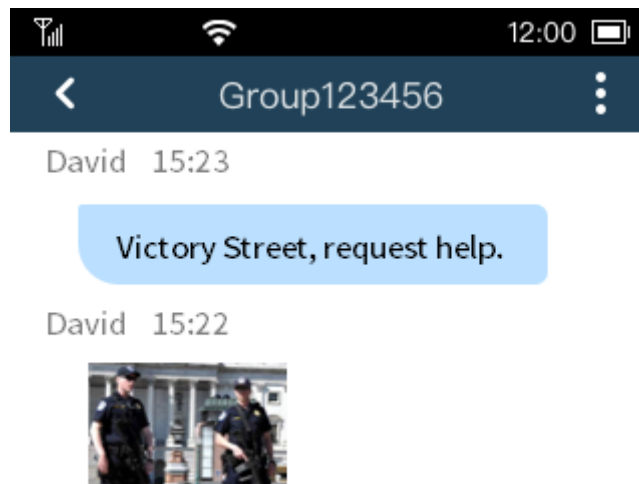

8. Supplementary Services

8.1 Monitoring via LDS

The LDS can listen to designated BWCs or groups. When the listened BWC or group involves in a voice call or message, the LDS also receives the voice call or message without noticing the BWC or group.

8.2 Override

The LDS can forcibly terminate a listened ongoing voice call and release the channel resource.

8.3 Interrupt

When a BWC user is speaking in a voice call, the LDS can forcibly interrupt the speaking subscriber and obtain the floor.

8.4 Stun

The LDS sends a stun command to the BWC, and disables the functions of the BWC. A stunned BWC can only log in and out of the system, but cannot perform other services.

8.5 Revive

The LDS sends a revive command to the BWC, and restores the stunned BWC with disabled functions. The revived BWC can work normally and perform the services.

8.6 Location Service

The location server subscribes the location information of the BWCs, and receives real-time BWC location report. Then the LDS subscribes the BWC location information directly from the location server.

8.7 LDS Subscription

The LDS subscribes information such as the device information, group information and call information from the server. Upon receiving the subscription request, the server sends back the requested information to the LDS. When the subscription is modified, the server sends the requested information to the LDS automatically. The information for subscription includes the correspondence between device and group, subscriber registration status, subscriber call status, group call status and the system online call status.

9. Playing Back Videos/Audios/Photos

1. Tap the library icon from the home screen.

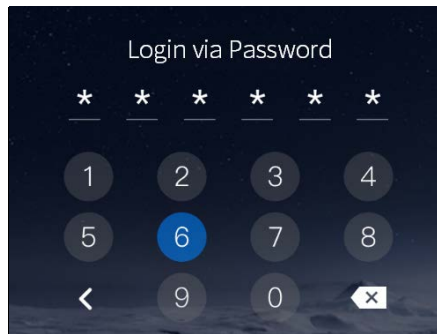

2. Enter the password (123456 as initial password) and then enter the following interface. Tap Photos, Audios or Videos to enter the playback list of the corresponding media.

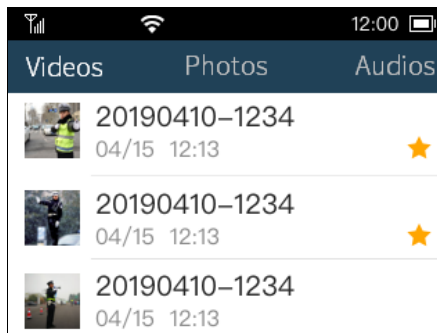

3. Tap the photo, audio or video in the playback list to play the media.



NOTE

To return to the home screen, press the Mode key.

10. Data Collection

You can switch the product into disk mode through the BWC Manager, and then copy photos, audios and videos to your PC. For details on the operations, refer to the *BWC Manager Operation Guide* in the BWC Manager folder. To connect the product with your PC, do as follows.

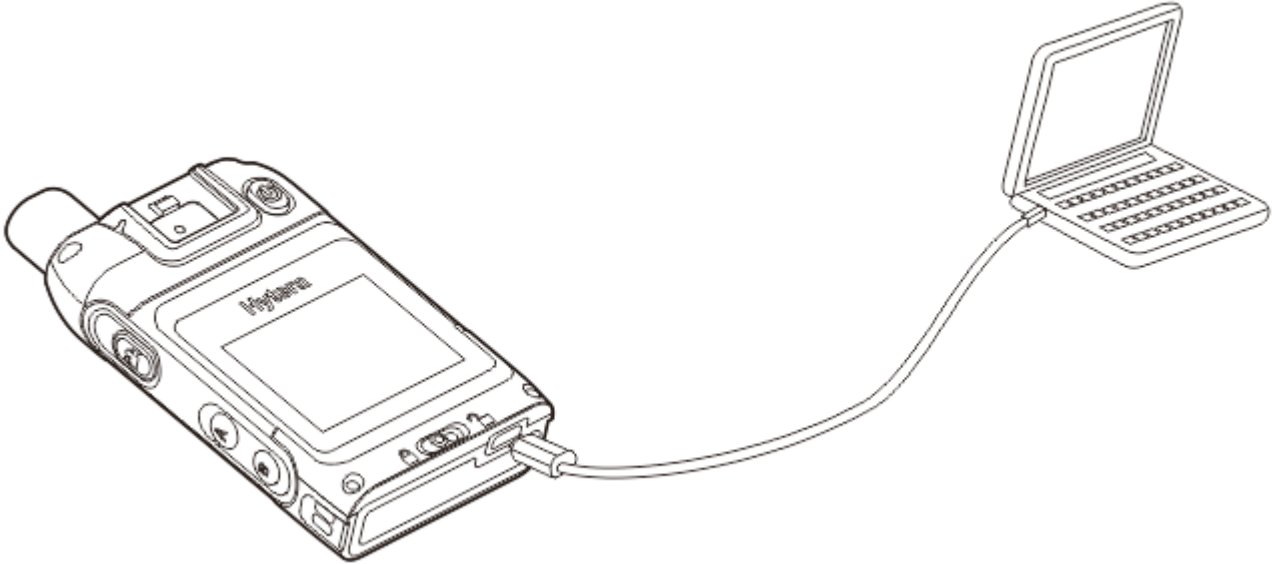

If you have purchased the multi-unit charger, you can also perform data collection through the charger. For details, refer to the related user manual.

11. Troubleshooting

Phenomena	Analysis	Solution
The product cannot be turned on.	The battery may be improperly attached.	Remove the battery and attach it again.
	The battery may run out.	Recharge or replace the battery.
	The battery and the charging probes are in poor contact due to dirtied or damaged battery contacts.	Clean the battery contacts.
The volume is low when playing back audios or videos.	The microphone and the speaker are blocked or damaged.	Clean the microphone and the speaker.
The product cannot record video or audio.	The TF card is full.	Switch to disk mode, and delete all data from the TF card after exporting them.
The product cannot take photo.	The TF card is full.	Switch to disk mode, and delete all data from the TF card after exporting them.
The product cannot pre-record or post-record the video.	The pre- or post-recording feature is not enabled.	Enable the feature.
The product does not turn on the IR LED automatically when recording video in dark environment.	The IR LED feature is not enabled.	Enable the IR LED feature.
The product gives no alert tone; the indicator does not light up.	The Silent Mode is enabled.	Disable the Silent Mode.

The product gives no response to operations.	The product has crashed.	Press the Power On/Off key for 10 seconds to forcibly turn the product off.
--	--------------------------	---

If the above solutions cannot solve your problems, or you may have some other queries, please contact us or your local dealer for more technical support.

12. Care and Cleaning

To guarantee optimum performance as well as a long service life of the product, please follow the tips below.

Product Care

- Do not pierce or scrape the product.
- Keep the product away from substances that can corrode the circuitry.
- Do not hold the product by the connection cable.

Product Cleaning



CAUTION

- Turn off the product and remove the battery before cleaning.
 - Make sure the product is completely dry before use.
-

- Clean up the dust and fine particles on the product surface with a clean and dry lint-free cloth or a brush regularly.
- Use neutral cleanser and a non-woven fabric to clean the keys and surface after long-time use. Do not use chemical preparations such as stain removers, alcohol, sprays or oil preparations, so as to avoid surface damage.

13. Optional Accessories



CAUTION

Use the accessories specified by Hytera only. Otherwise, we shall not be liable for any losses or damages arising out of the use of any unauthorized accessories.



is the trademark or registered trademark of Hytera Communications Corporation Limited. ©2020 Hytera Communications Corporation Limited. All Rights Reserved.

Address: Hytera Tower, Hi-Tech Industrial Park North, 9108# Beihuan Road, Nanshan District, Shenzhen, People's Republic of China

Postcode: 518057

[http:// www.hytera.com](http://www.hytera.com)